

SPEC. No. ED-04P142
ISSUE January 18, 2005

SHARP

OPTO-ELECTRONIC DEVICES DIVISION
ELECTRONIC COMPONENTS GROUP
SHARP CORPORATION

SPECIFICATION

DEVICE SPECIFICATION FOR

PHOTOCOUPLER

MODEL No.

PC354

Business dealing name

	PC354NJ0000F
	PC354N1J0000F

Specified for

Enclosed please find copies of the Specifications which consists of 11 pages including cover.
This specification sheets and attached sheets shall be both side copy.
After confirmation of the contents, please be sure to send back copies of the Specifications
with approving signature on each.

CUSTOMER'S APPROVAL

DATE

BY

PRESENTED

DATE

BY

/s/ , O,

H. Imanaka,
Department General Manager of
Engineering Dept., II
Opto-Electronic Devices Div.
ELECOM Group
SHARP CORPORATION

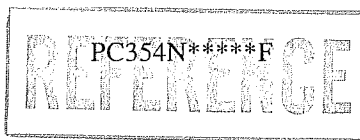

Product name : PHOTOCOUPLER

Model No. : PC354

Business dealing name

PC354NJ0000F
PC354N1J000F

1. These specification sheets include materials protected under copyright of Sharp Corporation ("Sharp"). Please do not reproduce or cause anyone to reproduce them without Sharp's consent.
2. When using this product, please observe the absolute maximum ratings and the instructions for use outlined in these specification sheets, as well as the precautions mentioned below. Sharp assumes no responsibility for any damage resulting from use of the product which does not comply with the absolute maximum ratings and the instructions included in these specification sheets, and the precautions mentioned below.

(Precautions)

(1) This product is designed for use in the following application areas ;

- OA equipment Audio visual equipment · Home appliances
- Telecommunication equipment (Terminal) · Measuring equipment
- Tooling machines · Computers

If the use of the product in the above application areas is for equipment listed in paragraphs (2) or (3), please be sure to observe the precautions given in those respective paragraphs.

(2) Appropriate measures, such as fail-safe design and redundant design considering the safety design of the overall system and equipment, should be taken to ensure reliability and safety when this product is used for equipment which demands high reliability and safety in function and precision, such as ;

- Transportation control and safety equipment (aircraft, train, automobile etc.)
- Traffic signals · Gas leakage sensor breakers · Rescue and security equipment
- Other safety equipment

(3) Please do not use this product for equipment which require extremely high reliability and safety in function and precision, such as ;

- Space equipment · Telecommunication equipment (for trunk lines)
- Nuclear power control equipment · Medical equipment

(4) Please contact and consult with a Sharp sales representative if there are any questions regarding interpretation of the above three paragraphs.

3. Please contact and consult with a Sharp sales representative for any questions about this product.

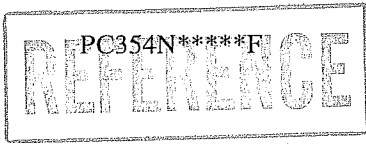

1. Application

This specification applies to the outline and characteristics of photocoupler Model No. PC354(Lead free type).

2. Outline Refer to the attached sheet, page 3.

3. Ratings and characteristics Refer to the attached sheet, page 4, 5.

4. Reliability Refer to the attached sheet, page 6.

5. Outgoing inspection Refer to the attached sheet, page 7.

6. Supplement

6.1 Isolation voltage shall be measured in the following method.

- (1) Short between anode and cathode on the primary side and between collector and emitter on the secondary side.
- (2) The dielectric withstanding tester with zero-cross circuit shall be used.
- (3) The wave form of applied voltage shall be a sine wave.

6.2 Packaging specifications Refer to the attached sheet, page 8, 9.

6.3 Business dealing name ("O" mark indicates business dealing name of ordered product)

Ordered product	Business dealing name	Rank mark	Ic (mA)
	PC354NJ0000F	with or without	0.2 to 4.0
	PC354N1J000F	A	0.5 to 1.5

Test conditions
$I_F = \pm 1.0\text{mA}$ $V_{CE} = 5\text{V}$ $T_a = 25^\circ\text{C}$

6.4 This Model is approved by UL.
Approved Model No. : PC354
UL file No. : E64380

6.5 This product is not designed against irradiation.
This product is assembled with electrical input and output.
This product incorporates non-coherent light emitting diode.

6.6 ODS materials
This product shall not contain the following materials.
Also, the following materials shall not be used in the production process for this product.
Materials for ODS : CFCs, Halon, Carbon tetrachloride, 1.1.1-Trichloroethane (Methyl chloroform)

6.7 Brominated flame retardants
Specific brominated flame retardants such as the PBBOs and PBBs are not used in this device component at all.

7. Notes

Precautions for Photocouplers : Attachment-1-1.

2. Outline

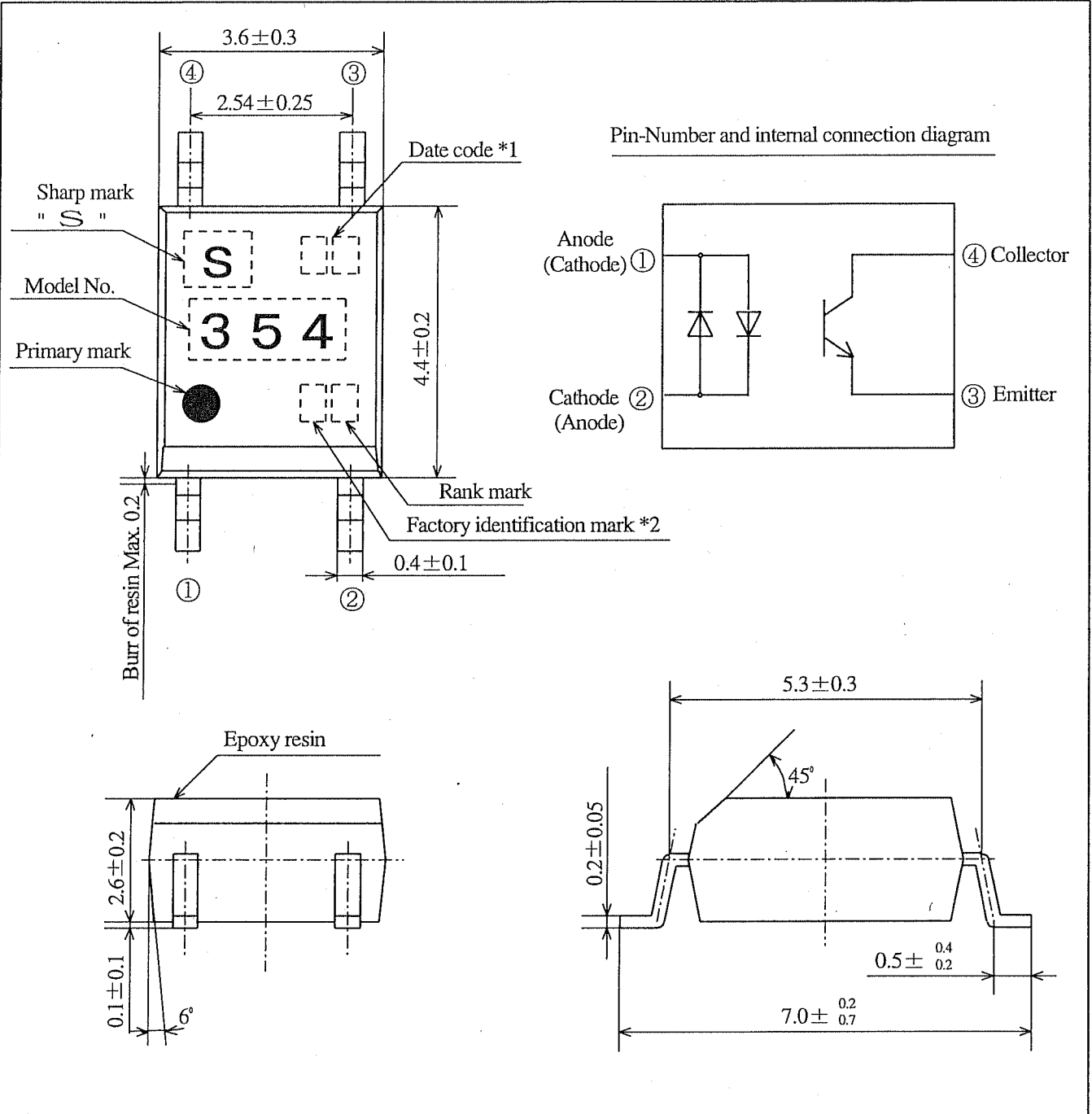

*1) 2-digit number shall be marked according to OLD DIN standard.
 *2) Factory identification mark shall be or shall not be marked.

Pin material : 42 Alloy
 Pin finish : SnCu plating (Cu : TYP. 2%)

Product mass : Approx. 0.1g

Marking is laser marking

UNIT : 1/1 mm	
Name	PC354 Outline Dimensions (Business dealing name : PC354N*****F)

3. Ratings and characteristics

3.1 Absolute maximum ratings

Ta=25°C

Parameter		Symbol	Rating	Unit
Input	*1 Forward current	I_F	±50	mA
	*2 Peak forward current	I_{FM}	±1	A
	*1 Power dissipation	P	70	mW
Output	Collector-emitter voltage	V_{CEO}	80	V
	Emitter-collector voltage	V_{ECO}	6	V
	Collector current	I_c	50	mA
	*1 Collector power dissipation	P_c	150	mW
*1 Total power dissipation		P_{tot}	170	mW
Operating temperature		T_{opr}	-30 to +100	°C
Storage temperature		T_{stg}	-40 to +125	°C
*3 Isolation voltage		$V_{iso(ms)}$	3.75	kV
*4 Soldering temperature		T_{sol}	260	°C

*1 The derating factors of absolute maximum ratings due to ambient temperature are shown in Fig. 1 to 4.

*2 Pulse width $\leq 100 \mu s$, Duty ratio : 0.001 (Refer to Fig. 5)

*3 AC for 1 min, 40 to 60%RH, f=60Hz

*4 For 10 s

3.2 Electro-optical characteristics

Ta=25°C

Parameter		Symbol	Conditions	MIN.	TYP.	MAX.	Unit
Input	Forward voltage	V_F	$I_F = \pm 20 \text{mA}$	-	1.2	1.4	V
	Terminal capacitance	C_t	$V=0, f=1\text{kHz}$	-	30	250	pF
Output	Dark current	I_{CEO}	$V_{CE}=50\text{V}, I_F=0$	-	-	100	nA
	Collector-emitter breakdown voltage	BV_{CEO}	$I_c=0.1\text{mA}, I_F=0$	80	-	-	V
	Emitter-collector breakdown voltage	BV_{ECO}	$I_E=10 \mu A, I_F=0$	6	-	-	V
Transfer characteristics	Collector current	I_c	$I_F = \pm 1 \text{mA}, V_{CE}=5\text{V}$	0.2	-	4.0	mA
	Collector-emitter saturation voltage	$V_{CE(sat)}$	$I_F = \pm 20 \text{mA}, I_c=1\text{mA}$	-	0.1	0.2	V
	Isolation resistance	R_{ISO}	DC500V 40 to 60%RH	5×10^{10}	10^{11}	-	Ω
	Floating capacitance	C_f	$V=0, f=1\text{MHz}$	-	0.6	1.0	pF
	Response time (Rise)	t_r	$V_{CE}=2\text{V}, I_c=2\text{mA}$ $R_L=100 \Omega$	-	4	18	μs
	Response time (Fall)	t_f		-	3	18	μs

(Fig. 1) Forward current vs. ambient temperature

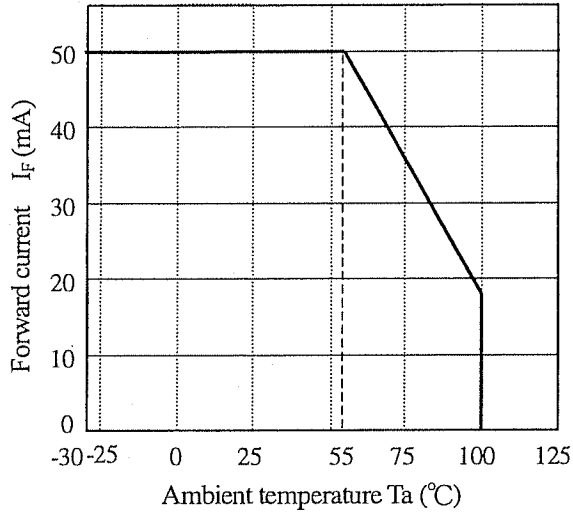

(Fig. 2) Diode power dissipation vs. ambient temperature

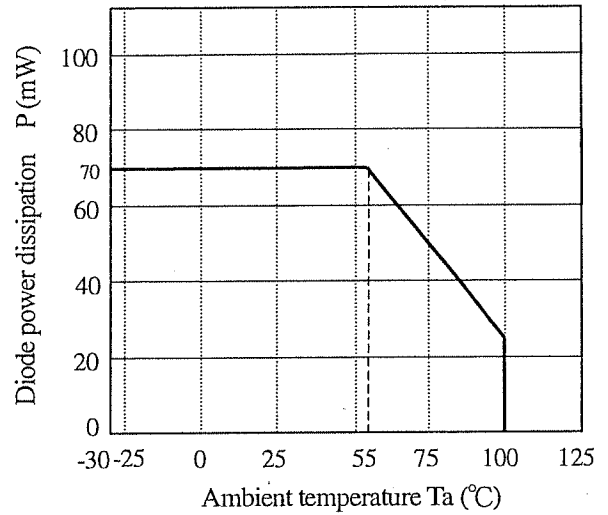

(Fig. 3) Collector power dissipation vs. ambient temperature

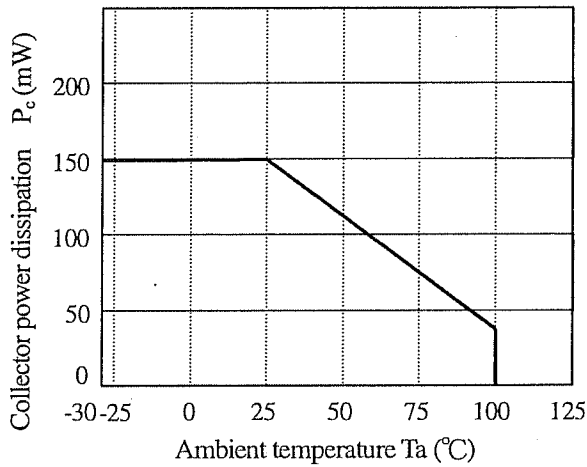

(Fig. 4) Total power dissipation vs. ambient temperature

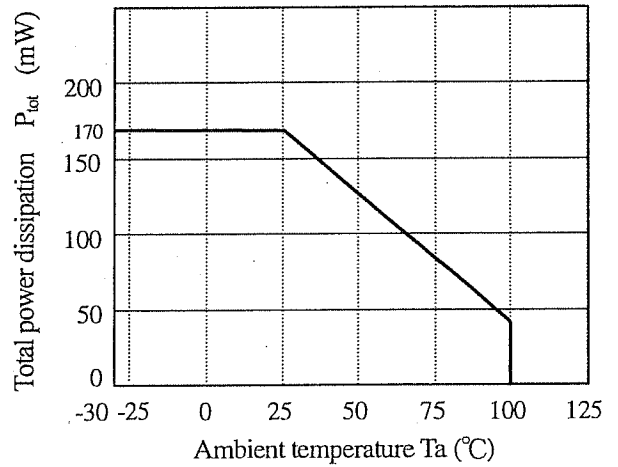

(Fig. 5) Peak forward current vs. duty ratio
 Pulse width $\leq 100\mu s$
 $T_a = 25^\circ C$

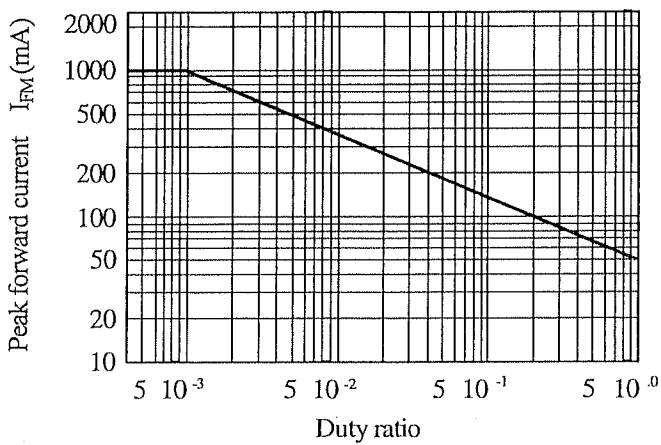

4. Reliability

The reliability of products shall satisfy items listed below.

Confidence level : 90%

LTPD : 10 or 20

Test Items	Test Conditions *1	Failure Judgment Criteria	Samples (n)
			Defective(C)
Solderability *2	245±3°C, 5 s	—————	n=11, C=0
Soldering heat *3	(Flow soldering) 260°C, 10 s	$V_F > U \times 1.2$ $I_{CEO} > U \times 2$ $I_C < L \times 0.7$ $V_{CE(sat)} > U \times 1.2$ U : Upper specification limit L : Lower specification limit	n=11, C=0
	(Soldering by hand) 400°C, 3 s		n=11, C=0
Terminal strength (Bending) *4	Weight : 1N 1 time/each terminal		n=11, C=0
Mechanical shock	15km/s ² , 0.5ms 3 times/±X, ±Y, ±Z direction		n=11, C=0
Variable frequency vibration	100 to 2000 to 100Hz/4min 200m/s ² 4 times/ X, Y, Z direction		n=11, C=0
Temperature cycling	1 cycle -40°C to +125°C (30min) (30min) 20 cycles test		n=22, C=0
High temp. and high humidity storage *5	+85°C, 85%RH, 500h		n=22, C=0
High temp. storage	+125°C, 1000h		n=22, C=0
Low temp. storage	-40°C, 1000h		n=22, C=0
Operation life	I _F =±50mA, P _{tot} =170mW Ta=25°C, 1000h		n=22, C=0

- *1 Test method, conforms to EIAJ ED 4701.
- *2 Solder shall adhere at the area of 95% or more of immersed portion of lead, and pin hole or other holes shall not be concentrated on one portion.
- *3 It is evaluated due to the temperature profile in attachment-1.
- *4 Terminal bending direction is shown below.
- *5 It is evaluated after washing by specified solvent in attachment-1.

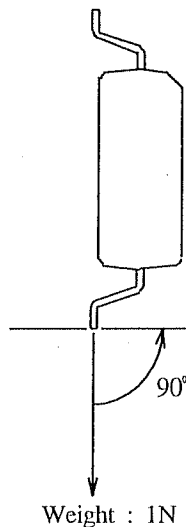

5. Outgoing inspection

5.1 Inspection items

- (1) Electrical characteristics

$V_F, I_{CEO}, V_{CE(sat)}, I_C, R_{ISO}, V_{iso}$

- (2) Appearance

5.2 Sampling method and Inspection level

A single sampling plan, normal inspection level II based on ISO 2859 is applied.

The AQL according to the inspection items are shown below.

Defect	Inspection item	AQL (%)
Major defect	Electrical characteristics Unreadable marking	0.065
Minor defect	Appearance defect except the above mentioned.	0.25

6.2 Package specifications

6.2.1 Taping conditions

- (1) Tape structure and Dimensions (Refer to the attached sheet, Page 8)
The carrier tape has the heat pressed structure of A-PET material carries tape with preventing static electricity and three layers cover tape (PET material base).
- (2) Reel structure and Dimensions (Refer to the attached sheet, Page 9)
The taping reel shall be of plastic (PS material).
- (3) Direction of product insertion (Refer to the attached sheet, Page 9)
- (4) Joint of tape The cover tape and carrier tape in one reel shall be joint less.
- (5) To repair failure - taped devices, cutting a bottom of carrier tape with a cutter.
After replacing the cut portion shall be sealed with adhesive tape.

6.2.2 Adhesiveness of cover tape

- The exfoliation force between carrier tape and cover tape shall be 0.2N to 0.7N for the angle 160° to 180° .

6.2.3 Rolling method and quantity

- Wind the tape back on the reel so that the cover tape will be outside the tape.
Attach more than 20cm of blank tape to the trailer and the leader of the tape and fix the both ends with adhesive tape. One reel basically shall contain 3000pcs.

6.2.4 Outer packing appearance (Refer to the attached sheet, page 9)

6.2.5 Marking

- The label with following information shall be pasted at appointed place of the outer packing case.
* Model No. * Number of pieces delivered * Production date

6.2.6 Storage condition

- Taped products shall be stored at the temperature between 5 and 30°C and the humidity lower than 70%RH away from direct sunlight.

6.2.7 Safety protection during shipping

- There shall be no deformation of component or degradation of electrical characteristics due to shipping.

Carrier tape structure and Dimensions

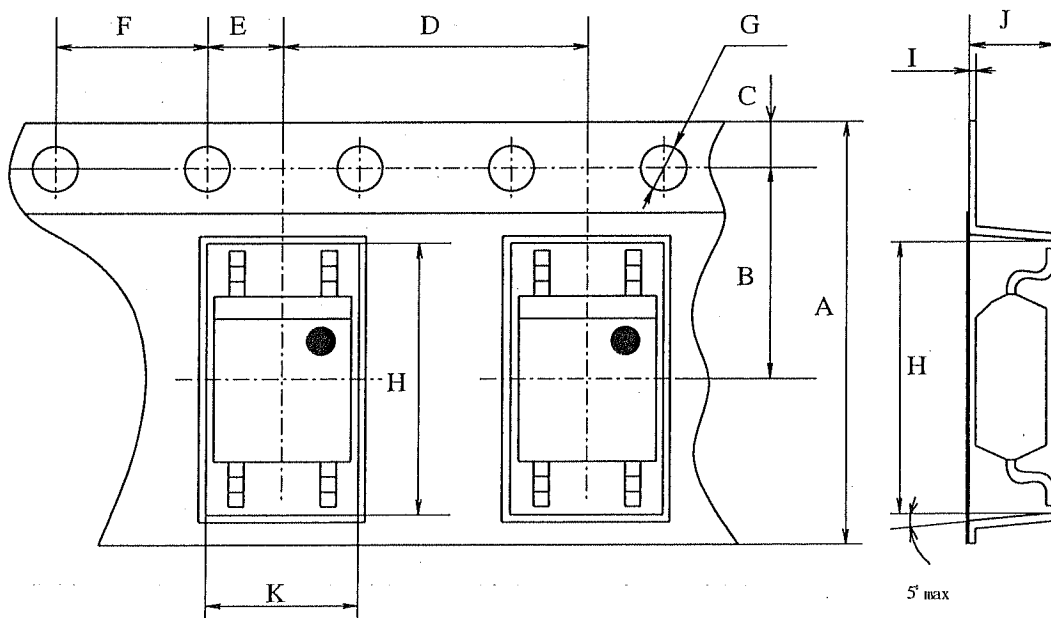

Dimensions list (Unit : mm)

A	B	C	D	E	F	G	H	I	J	K
±0.3	±0.05	±0.10	±0.1	±0.1	±0.1	+0.1 -0.0	±0.1	±0.05	±0.1	±0.1
12.0	5.50	1.75	8.0	2.0	4.0	φ 1.5	7.4	0.30	3.1	4.0

Reel structure and Dimensions

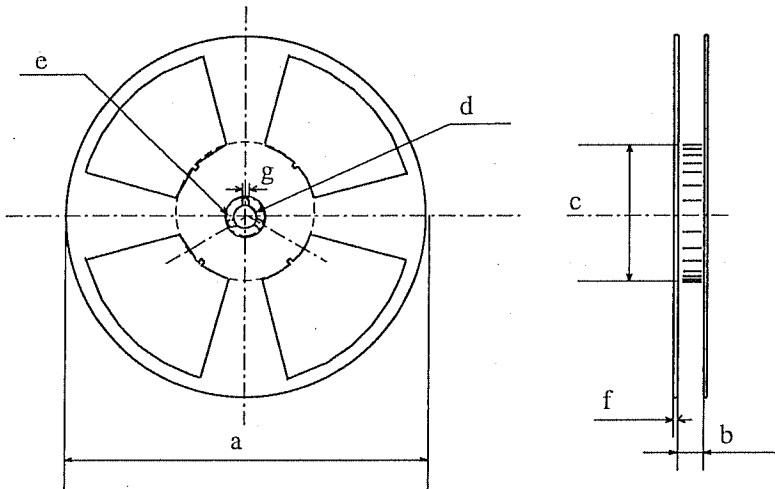

Dimensions list (Unit : mm)

a	b	c	d
370	13.5 ± 1.5	$\phi 80.0 \pm 1.0$	$\phi 13.0 \pm 0.5$
e	f	g	
$\phi 21.0 \pm 1.0$	2.0 ± 0.5	2.0 ± 0.5	

Direction of product insertion

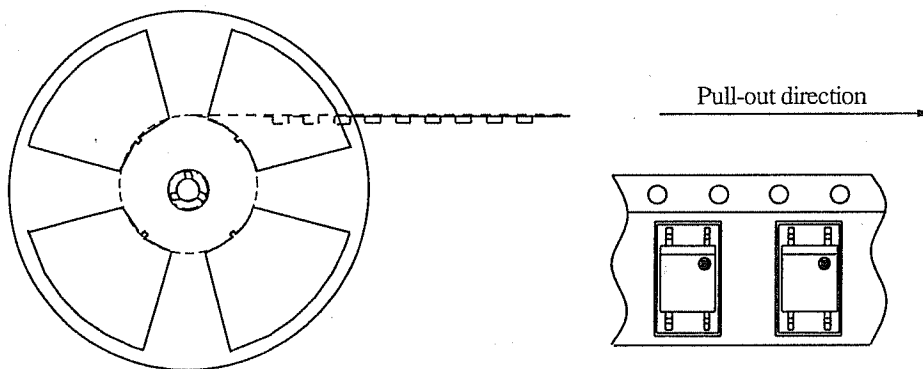

Outer packing appearance

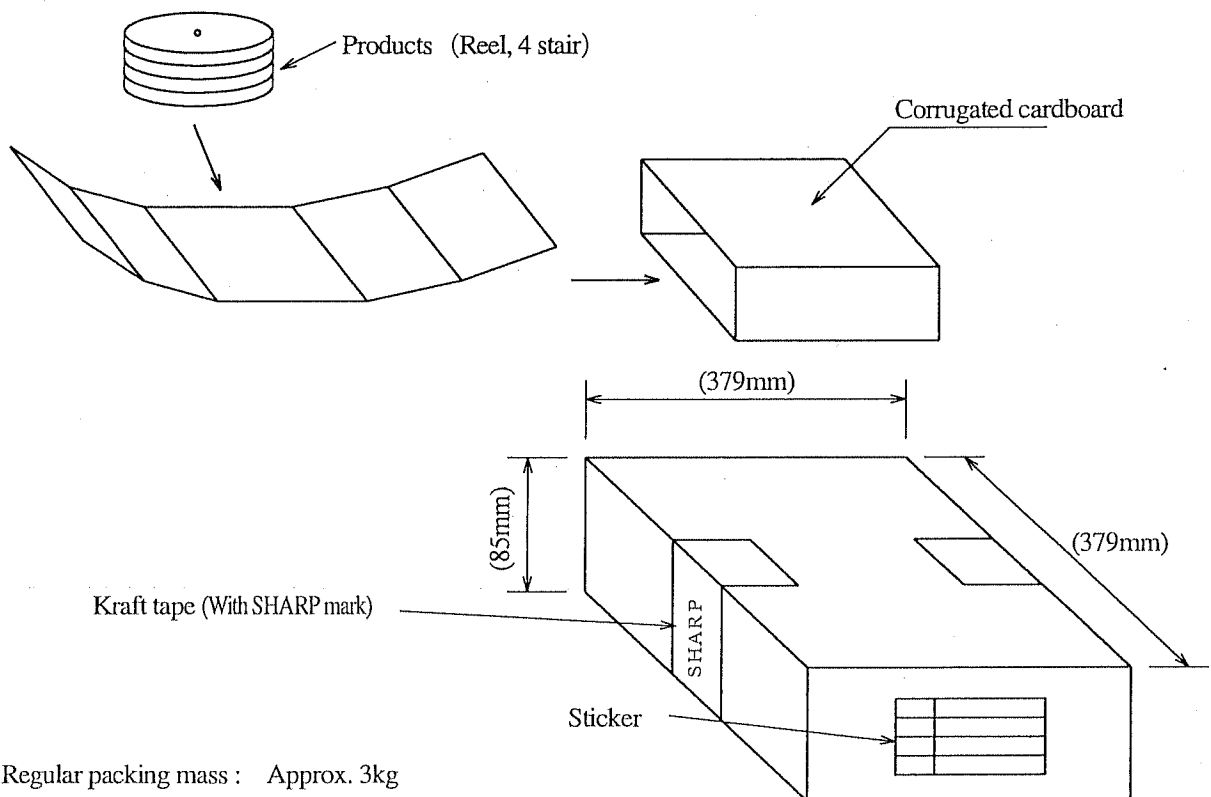

Regular packing mass : Approx. 3kg

() : Reference dimensions

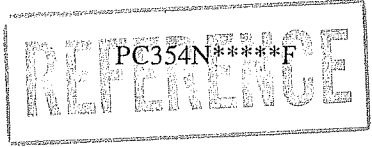

Precautions for Photocouplers

1. Cleaning

- (1) Solvent cleaning : Solvent temperature 45°C or less
Immersion for 3 min or less
- (2) Ultrasonic cleaning : The effect to device by ultrasonic cleaning differs by cleaning bath size, ultrasonic power output, cleaning time, PCB size or device mounting condition etc. Please test it in actual using condition and confirm that any defect doesn't occur before starting the ultrasonic cleaning.
- (3) Applicable solvent : Ethyl alcohol, Methyl alcohol, Isopropyl alcohol
When the other solvent is used, there are cases that the packaging resin is eroded.
Please use the other solvent after thorough confirmation is performed in actual using condition.

2. Circuit design

- (1) The LED used in the Photocoupler generally decreases the light emission power by operation.
In case of long operation time, please design the circuit in consideration of the degradation of the light emission power of the LED. (50%/5years)
- (2) There are cases that the deviation of the CTR and the degradation of the relative light emission power of the LED increase when the setting value of I_F is less than 1.0mA. Please design the circuit in consideration of this point.

3. Precautions for Soldering

- (1) In the case of flow soldering (Whole dipping is possible.)
It is recommended that flow soldering should be at 260°C or less for 10 s or less (Pre-heating : 100 to 150°C, 30 to 80s).
(2 times or less)
- (2) If solder reflow :
It is recommended to be done at the temperature and the time within the temperature profile as shown in the figure below. (2 times or less)

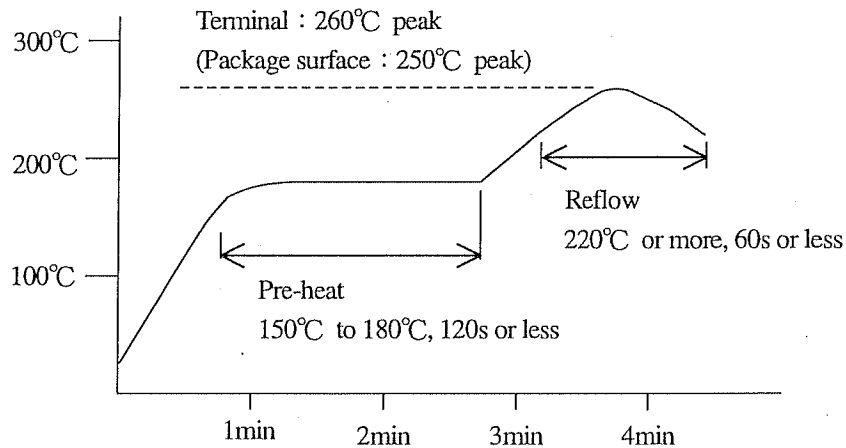

- (3) In the case of hand soldering
What is done on the following condition is recommended. (2 times or less)
Soldering iron temperature : 400°C or less
Time : 3s or less
- (4) Other precautions
Depending on equipment and soldering conditions (temperature, Using solder etc.), the effect to the device PCB is different.
Please confirm that there is no problem on the actual use conditions in advance